

USER MANUAL



SERIES COMPRESSOR SPRAY GUN

THE PERFECT FINISH STARTS WITH

FUJISPRAY™
AUTO

CONTENTS

Specifications	2
Safety Precautions	3 - 4
Assembly	5
Operation	6 - 7
Technique	7
Parts Diagram	8 - 9
Air Cap Sets	10
Finish Problems	10
Troubleshooting	11 - 12
Cleaning	13 - 14
Reassembly	14 - 15
Disassembly for Service or Repairs	16
Warranty Information	17

SPECIFICATIONS

Max. cfm at psi

MP	Max. 12.2 cfm at 35 psi
HVLP	Max. 14.7 cfm at 28 psi

Air Consumption

MP	12.2 cfm
HVLP	14.7 cfm

Operating Pressure Range

MP	9 to 35 psi
HVLP	9 to 28 psi

Standard Air Cap Set

MP	1.3mm
HVLP	1.4mm

Air Inlet Size	1/4" BSP and NPS
Air Supply Hose Width	5/16" ID
Fluid Coupler Size (Gravity)	3/8" PF
Gun Weight (Without Cup)	521g
Nozzle Sizes Available (in mm)	1.2; 1.3; 1.4; 1.7; 2.0; 2.2

Spray Gun Materials

Body	Forged Aluminum
Air Cap	Nickel Plated Brass
Nozzle	Stainless Steel
Needle Spring	Stainless Steel
Fluid Passages	Anodized Aluminum
Seal Gaskets	PTFE (Teflon)

Please read these instructions before using the equipment



FIRE AND EXPLOSION HAZARD

Equipment must not be used in an area contaminated by volatile or flammable materials. This could ignite the contaminants causing a dangerous explosion.

- Do not spray flammable or combustible materials near an open flame or sources of ignition such as cigarettes, motors, and electrical equipment.
- Never use 1,1,1-Trichloroethane, Methylene Chloride, other Halogenated Hydrocarbon solvents or fluids containing such solvents in equipment with aluminum wetted parts. Such use could result in a serious chemical reaction, with the possibility of explosion. Consult your fluid suppliers to ensure that the fluids being used are compatible with aluminum parts.
- Always keep spray area well-ventilated. Always keep a good supply of fresh air moving through the area.
- Do not smoke in the spray area.
- Do not operate light switches, engines, or similar spark producing products in the spray area.
- Always keep area clean and free of paint or solvent containers, rags, and other flammable materials.
- Fire extinguisher equipment shall be present and working.



TOXIC FLUID OR FUMES HAZARD

Toxic fluids or fumes can cause serious injury or death if splashed in the eyes or on skin, inhaled, or swallowed.

- Read MSDS (Material Safety Data Sheet) to know the specific hazards of the fluids you are using.
- Always wear appropriate gloves and eye protection.
- Always wear a respirator. Read all instructions of the respirator to ensure that it will provide the necessary protection against the inhalation of harmful vapors. Also check with the local jurisdiction.
- Paint, solvents, insecticides and other materials may be harmful if inhaled.
- Store hazardous fluid in approved containers and dispose of it according to applicable guideline.
- Do not stop or deflect fluid leaks with your hand or body.



EQUIPMENT MISUSE HAZARD

Misuse of equipment can cause serious injury or death.

- Health and safety, accident prevention, work and environment protection regulations and policies are mandatory.
- Never aim the Spray Gun at another person or animal. In the event of injury, seek expert medical attention immediately.
- Do not operate or spray near children. Always keep children away from equipment at all times.
- Do not overreach or stand on an unstable support. Always keep effective footing and balance.
- Stay alert and watch what you are doing.
- Do not operate the unit when fatigued or under the influence of drugs or alcohol.
- Check the hose, hose connectors and Spray Gun before every use. Any worn or damaged parts should be replaced immediately.
- Before performing any maintenance to the equipment, de-energize, depressurize, disconnect and lock out all power sources.
- Use only genuine Fuji Spray replacement parts. Never modify the equipment.



STATIC CHARGE HAZZARD

Static electricity may be produced by fluid. Make sure any electrically conductive object being sprayed, spray area, and spray equipment is properly grounded to prevent static sparking. Improper grounding or sparks can cause a hazardous condition and result in electric shock, fire, or even explosion and other serious harm.



Prop 65 for California Residents

WARNING: This product may contain chemicals known to the State of California to cause cancer, birth defects, or other reproductive harm

Warning: Sound levels produced by spray guns during use may be harmful to the ear depending on the set-up. It is recommended that ear protection is always worn at all times when spraying.

THE EMPLOYER IS RESPONSIBLE TO PROVIDE THIS INFORMATION TO THE OPERATOR OF THE EQUIPMENT

ASSEMBLY

Cup Assembly Installation:

Insert Paint Strainer into the base of the Cup from the outside. Attach the cup assembly by screwing into the Fluid Coupler of the Spray Gun. Hand-tightened is enough.

Connecting to Air Supply:

1. Attach pressure regulator with gauge (not included) to the Spray Gun's air inlet
2. Attach hose connector fitting (not included) to pressure regulator with gauge
3. Connect air supply hose

(OPTIONAL) Attach hose connector fitting directly to the Spray Gun's air inlet and connect air supply hose

NOTE: For best spray results, it is recommended using a 5/16" ID air pressure hose. If hose is over 20ft then a 3/8" diameter would be ideal. Using a smaller diameter hose will result in a significant drop in pressure.

NOTE: Air supply must be clean, moisture free, oil free air and properly regulated.

Most HVLP and MP (Mid-Pressure or reduced pressure) compressor Spray Guns will operate between 10 and 20cfm. A 20cfm Spray Gun will drain the air from a moderate sized 5hp compressor. If an additional air tool is connected to the circuit and used during this time, the Spray Gun's atomizing pressure will vary. This will result in a lower quality performance and inconsistent outcome. For best results, a larger compressor is recommended.

OPERATION

To clean out any impurities that may have accumulated during assembly or shipping of the Spray Gun, we recommend spraying a small quantity of clean paint thinner through the gun. If you intend to spray water-based paints and materials, make sure fluid passages and components that may have come in contact with paint thinner are completely dry.

- Mix material to manufacturer's requirements, and properly strain.
- Fill the material cup no more than maximum 3/4 full - Do not overfill.
- As a safety guard and reference point, turn Fluid Control Knob (#15) clockwise, do not force. This will prevent any accidental trigger pull as you complete setting up.
- Turn the Fan Pattern Control Knob (#16-6) counter-clockwise, this will set the Spray Gun to the widest fan pattern.
- Connect air supply to the Spray Gun and rotate the Fluid Control Knob (#15) counter-clockwise two full turns. This will allow for some material to flow out of the Nozzle to atomize.
- Point Spray Gun away from you, pull the trigger and gauge the Spray Gun's settings. You may need to adjust material flow, air pressure, or fan pattern settings at this time to achieve desired settings.

Fluid Control - If the material flow is too heavy, turn the Fluid Control Knob clockwise, this will reduce material volume flow. To increase material volume flow for a wet finish, turn the Fluid Control Knob counter-clockwise.

Pressure Regulator - Air pressure adjustment will significantly affect how the material is atomized. If looking too coarse when wet, increase air supply pressure at the pressure regulator located at base of the Spray Gun's handle. If looking too fine, decrease pressure. For pressure specifications of the Spray Gun, see page 2.

Pattern Control - To produce a smaller fan pattern, turn the Fan Pattern Control Knob (#16-6) clockwise. For widest pattern, turn Fan Pattern Control Knob counter-clockwise.

NOTE: In most cases, a combination of all three adjustments will provide the desired results.

TECHNIQUE

The Spray Gun should be held perpendicular to the surface at all times. Hold the gun no more than 8" (20cm) away from the surface to be sprayed.

CORRECT METHOD

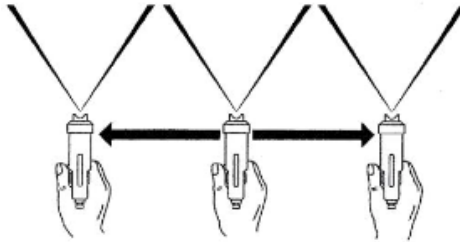

Begin spraying by pulling the Trigger and move the Spray Gun in the direction you want to spray. Start your pass from off the edge of the piece; then continue off the edge of the piece on the other end before releasing the Trigger. Between each successive pass, overlap by 50%.

INCORRECT METHOD

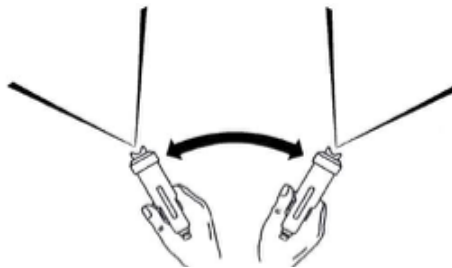

CAUTION: Never for any reason point the Spray Gun directly at the face or head of a person.

FUJI SPRAY AUTO™ V8 SERIES SPRAY GUN

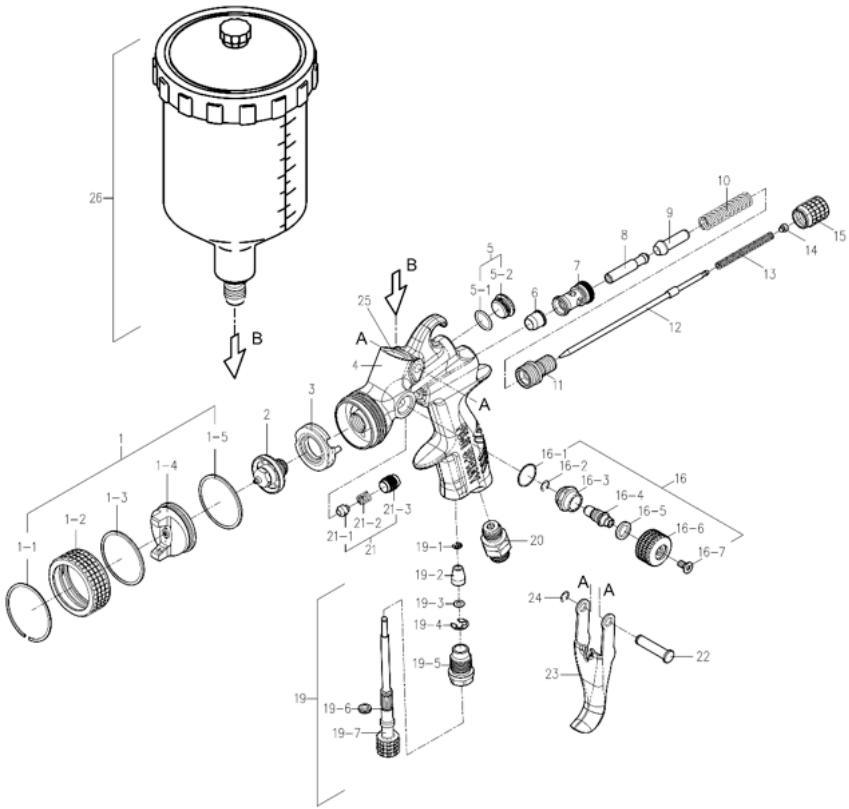

	ITEM	PART	NAME
	1		Air Cap with Collar
	1-1		Air Cap Retaining Ring
	1-2		Collar
	1-3		Air Cap O-Ring
	1-4		Air Cap
	1-5		Collar Seal
••	2		Fluid Nozzle
••	3	6803	Air Distributor
	4		Gun Body
	5	6805	Rear Barrel Plug with Seal

	PART	DESCRIPTION
••	6882	Spray Gun Rebuild Kit consists of one each of these parts
•		Parts not removable

	ITEM	PART	NAME
	5-1		Rear Barrel Plug Seal
	5-2		Rear Barrel Plug
•	6		Valve Seal
•	7		Spindle Valve Housing
••	8	6808	Spindle Valve Bushing
••	9	6809	Spindle Valve
••	10	6810	Spindle Valve Spring
••	11	6811	Fluid Screw Nut
	12		Needle
••	13	6813	Needle Spring
••	14	6814	Needle Spring Cap
••	15	6815	Fluid Control Knob
	16	6816	Fan Pattern Control Assembly
	16-1		Fan Assembly Valve Seal
	16-2		Fan Assembly Valve Retaining Ring
	16-3		Fan Assembly Valve Housing
	16-4		Fan Assembly Valve
	16-5		Fan Assembly O-Ring
	16-6		Fan Pattern Control Knob
	16-7		Fan Pattern Control Knob Screw
	19	6819	Air Control Assembly
	19-1		Air Control Seal Valve Locking Ring
	19-2		Air Control Seal Valve
	19-3		Air Control Seal Valve Washer
	19-4		Air Control Housing Locking Ring
	19-5		Air Control Housing
	19-6		Air Control Knob O-Ring
	19-7		Air Control Knob
•	20		Air Inlet
••	21	6821	Needle Packing Assembly
	21-1		Needle Packing
	21-2		Needle Packing Spring
	21-3		Needle Packing Nut
	22	6822	Trigger Pin
	23	6823	Trigger
	24	6824	Trigger Retaining Ring
•	25		Fluid Coupler
	26	6840	600cc Gravity Nylon Cup (6841 - Aluminum)

AIR CAP SETS

Air Cap Set Sizes (Sold Separately)	Part Number MP	Part Number HVLP
1.2mm	6800MP-V8-1.2	6890H-V8-1.2
1.3mm (Standard MP-V8)	6800MP-V8-1.3	6890H-V8-1.3
1.4mm (Standard H-V8)	6800MP-V8-1.4	6890H-V8-1.4
1.7mm	6800MP-V8-1.7	6890H-V8-1.7
2.0mm	6800MP-V8-2.0	6890H-V8-2.0
2.2mm	6800MP-V8-2.2	6890H-V8-2.2

FINISH PROBLEMS

PROBLEM	CAUSE	FIX
ORANGE PEEL - Finish is rough and resembles orange peel. Surface is spotty	Material is too thick	Add more thinner (or appropriate solvent)
	Air inlet pressure is too low	Increase air pressure to the gun
	Drying too fast	Add retarder
	Too close to surface	Keep distance 8" (20cm) away from surface
	Fluid Volume Control Knob set to heavy flow	Turn Fluid Control Knob clockwise to decrease flow Spray an extremely thin film, but still wet coat
	Surface is rough or dirty	Prep or clean thoroughly
GRITTY FINISH - Sprayed surface is rough and dry to the touch	The material is too thin, it is likely to be over-atomized	Set the fluid control knob to increment material flow Spray a wetter coat
	Too far from surface	Keep distance 8" (20cm) away from surface
	Contaminated surface	Prep and clean thoroughly
FISH EYES - A sprayed surface or spot that the material does not adhere to	Contamination such as silicone or oil on the surface that interferes with the finish	Thoroughly clean, wash or sand the area, then spray over. Start with light coats
RUNS AND SAGS - When paint/material is pooling in an area causing drips	Fluid Volume Control Knob set to heavy flow	Turn Fluid Control Knob clockwise to decrease flow
	The speed of your pass is too slow	Bring your pass to a moderate speed
	Inconsistent distance from surface per pass	Keep distance 8" (20cm) away from surface. See page 7 - Technique

TROUBLESHOOTING

SPRAY GUN PROBLEMS

PROBLEM	CAUSE	FIX
NO PAINT OR VERY LITTLE PAINT	No pressure from air supply hose	Check for air leaks on hose or adjust to appropriate pressure
	The air passage in Lid of the Cup may be obstructed	Clean obstruction at pinhole located on Lid of the Cup
	Cup is empty	Refill Cup with material
	Strainer may be clogged	Replace/remove Strainer
	Fluid Coupler is blocked with material	Clean Fluid Coupler
UNEVEN SPRAY PATTERN	One of the holes in the Air Cap may be blocked	Remove Air Cap or Nozzle and clean by soaking in appropriate solvent and using a soft bristle brush or a rag. NEVER use metal objects to clean holes in the Air Cap.
	The material could be contaminated and partially blocking Fluid Nozzle	
LEAKAGE If material comes out of the Fluid Nozzle without pulling the Trigger...	The Needle is not seating in Fluid Nozzle properly - check if Needle or Fluid Nozzle is damaged or worn	Lubricate Needle or Replace Needle and Fluid Nozzle
	Foreign matter trapped between Needle and Fluid Nozzle	Remove Needle and Fluid Nozzle and thoroughly clean
	Loose Fluid Nozzle	Tighten Fluid Nozzle
	Wrong Fluid Nozzle or Needle size installed	Check and install correct Fluid Nozzle or Needle size to match

SPRAY GUN PROBLEMS CONTINUED

PROBLEM	CAUSE	FIX
CUP LEAKS	Cup or Lid may be cracked	Replace Cup Assembly
	Cup Lid is too loose	Tighten Cup Lid - hold Cup (not Gun) with one hand, and tighten Lid with the other
THE TRIGGER IS SLUGGISH	Bent Needle or not lubricated	Replace
		Lubricate shaft of needle
POOR SPRAY PATTERN	Damaged Needle or Nozzle	Replace
	Air holes in Air Cap or Nozzle clogged	Clean Air Cap or Fluid Nozzle
	Damaged Air Cap	Replace
	Gun too far from surface	Keep consistent distance of 8" - 20cm from surface
PAINT AT THE AIR NOZZLE HOLES	Fluid Nozzle is loose and material is leaking around it	Tighten with supplied Wrench
GUN SPRAYS IN A PULSATING MANNER	Cup is almost empty	Refill Cup with material
	Blocked fluid passage	Thoroughly clean fluid passages with appropriate solvent
	Air passage in the Lid of the Cup may be obstructed	Clean obstruction at pinhole located on Lid of the Cup
	Fluid Nozzle is loose or damaged	Tighten with supplied Wrench or replace

CAUTION

With the standard 600cc Gravity Cup installed on the Gun, do not lay the Gun down on its side with material in it.

CLEANING

GENERAL CLEANING

It is very important to properly clean your Spray Gun after each use. This will prevent any build-up and/or contamination when spraying other materials. Keeping your Spray Gun clean will also prevent spray problems due to blockage.

PLEASE DO NOT USE A WIRE BRUSH OR ANYTHING METAL TO CLEAN THE GUN OR CUP AS THIS WILL CAUSE DAMAGE. We recommend using the Fuji Spray Gun Cleaning Kit (part # 3100).

WARNING
DO NOT remove the Fluid Coupler (#25), the threads in your Spray Gun have been sealed at the factory to prevent leakage.

CAUTION
Never soak the complete Spray Gun in solvent as this is detrimental to the seals and removes the lubricants from parts.

CLEANING FLUID PASSAGES (Level 1)

1. Remove lid of the cup and pour left over material into a container
2. Wipe the inside of the cup with a solvent-soaked cloth
3. Add some appropriate solvent into the Cup, reattach Lid to the cup and spray
4. Pull the trigger repeatedly to properly flush the fluid passages, Needle and Nozzle
5. This process flushes solvent through the Spray Gun while it is still connected to the air supply hose and the paint is still wet inside the Gun.

If this type of quick cleaning is performed frequently, the Spray Gun will function well for many years. More than 50% of problems with a Spray Gun stem from clogs in the fluid passages and perhaps more important, the air passages.

THOROUGH CLEANING (Level 2)

DISSASSEMBLY - See page 16 for images

You may soak only the metal parts in neutral cleaning solution (pH value 6 to 8) and clean with the soft bristle cleaning brush.

After performing Level 1 cleaning and removing the gravity cup from the Spray Gun:

1. Fig. A - Remove Fluid Control Knob #15 and Needle Spring with Cap #13 and #14
2. Fig. B - Pull the Trigger #23 and the Needle #12 will extend from the rear of the gun
3. Fig. C - Carefully slide the Needle #12 out - Do not bend
4. Fig. D - Remove the Air Cap with Collar #1
5. Fig. E - Using the supplied Wrench, remove the Fluid Nozzle #2
6. Fig. F - Remove Air Distributor #3 and inspect for material residue
7. Fig. G - Use the supplied cleaning brush and appropriate solvent to clean behind the Fluid Nozzle #2
8. Fig. H - Soak the Air Cap with Collar #1, Nozzle #2 and Needle #12 in appropriate solvent, and clean. It is not necessary to soak or clean Air Distributor #3 unless there are traces of material on it

After cleaning the Spray Gun, it is recommended that the fluid passages, threads and cup be blown dry with clean compressed air.

Prior to assembly, always make sure ALL Gun components are present. Assembly of Spray Gun with missing parts may cause damage or harm.

REASSEMBLY

To reassemble, first oil or grease all moving and threaded parts.

1. Fig. I - Match the Locating Pin of the Air Distributor #3 to Gun Body
2. Fig. E - Attach Fluid Nozzle #2 and tighten with the supplied Wrench
3. Fig. D - Screw in the Air Cap with Collar #1
4. Fig. J - Add lubricant to the shaft of the Needle #12
5. Fig. C - Carefully slide in the Needle - Do not bend
6. Fig. A - Add Needle Spring with Cap #13 and #14 and attach Fluid Control Knob #15

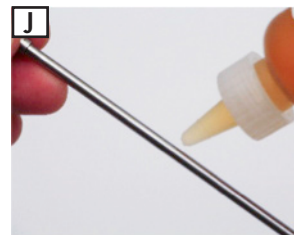
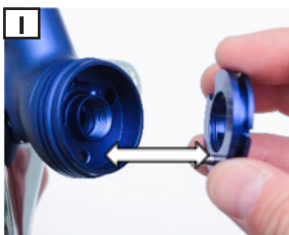
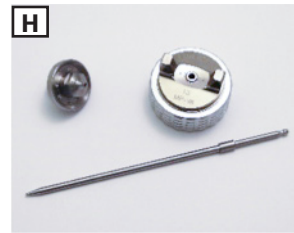
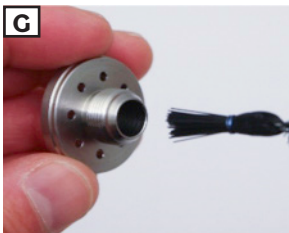
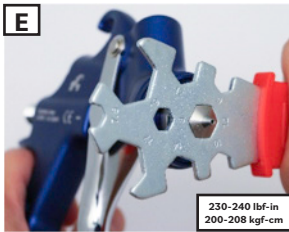

DISASSEMBLY

Disassembly for Service or Repairs

Needle Packing Nut Assembly

Follow instructions on page 15 up to #6, then follow the steps below:

1. Fig. K - Use an Allen Key size 6 to remove Fluid Screw Nut # 11, Then remove Spindle Valve Spring #10, Spindle Valve #9 and Spindle Valve Bushing #8
2. Fig. L - Remove Trigger #23 by unclipping Retaining Ring #24 with a size 0.375" (7/64") Retaining Ring Tool from Trigger Pin #22 and slide out. This will release Trigger #23
3. Fig. M - Remove Needle Packing Nut Assembly #21 by inserting long end of supplied Allen Key from rear of Spray Gun. Push Allen Key all the way through until the end almost comes out at front of Spray Gun. Turn Allen Key counter-clockwise to unscrew Needle Packing Nut Assembly #21

Fan Pattern Control Assembly

1. Fig. N - Remove Fan Pattern Control Knob Screw #16-7 using Torx screwdriver. Remove Pattern Control Knob #16-6
2. Fig. O - With a wrench, unscrew Pattern Control Assembly #16

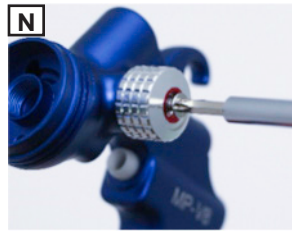
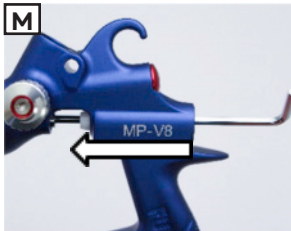
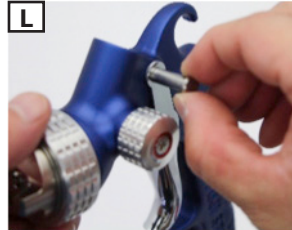
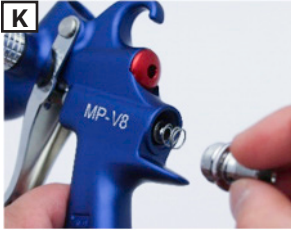

Fuji Spray Auto™ Limited 1 Year Warranty

Fuji Industrial Spray Equipment Ltd. (“Fuji”) provides a 12 month limited warranty on the product to the original purchaser effective from the date of purchase against defects in materials and workmanship.

The warranty does not cover damage or defects arising as a result of abuse, misuse, accident, negligence, malfunction, corrosion, normal wear and tear, inadequate or lack of spray gun or other aspects of maintenance of the product, damage arising from improper assembly, installation or operation, damage arising from the product being used with parts that are not genuine Fuji Spray® parts, or damage arising from the product being used for a purpose other than that for which it was designed or intended. The warranty is void if repairs to the product are made or attempted by anyone other than Fuji or its authorized agent, or if any modifications to the product are made or attempted.

Purchasers located in North America must obtain a Return Material Authorization number by calling Fuji at 1-800-650-0930 before returning the product to Fuji or its designated representative.

Purchasers located outside North America must contact the vendor from which they purchased the product. In all instances purchasers must return the product together with proof of purchase and with shipping prepaid. For valid warranty claims the product will be returned to the purchaser with shipping prepaid.

This is the only warranty provided by Fuji with respect to the product and is in lieu of any other warranties, express or implied, including but not limited to any warranty of merchantability or fitness for a particular purpose. Fuji’s sole obligation under this warranty shall, at its option, be to either repair or replace a product determined by Fuji to be defective. In no event shall Fuji be liable for loss or profits, incidental or consequential damages, injury to any person or property, or any other damages of whatsoever nature.

FUJI SPRAY® AUTO

CONNECT WITH US!

 @FUJISPRAYAUTO

 @FUJISPRAYAUTO

 @FUJISPRAY

NEED HELP?

 FUJISPRAY.COM
FUJISPRAYAUTO.COM

 AUTO@FUJISPRAY.COM

 +1 (800) 650 0930

Fuji Industrial Spray Equipment Ltd.
40 Magnetic Drive. #48, Toronto, ON, Canada M3J 2C4